



V82 Series Ball Valves

Pressure Rating up to 3000psig

Catalog No. V82-3
April 2008

Features of V82 Series

- Sealing is achieved without system pressure
- Pressure up to 3000 psig (206 bar)
- Bi-directional flow
- Lowest dead space design

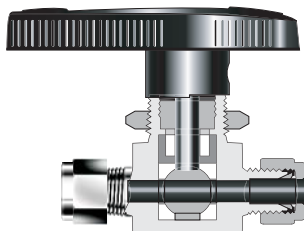

- **Nylon Directional handle** - indicates the flow through the valve.
- **Panel mounting nut** - is standard and permits valve to panel or actuator.
- **Top-loaded packing** - allows packing adjustment with the valve in-line.
- **Capsule packing** - fills voids in the valve body and prevents fluid entrapment. - allows lowest dead space.
- **Support rings and discs** - retains the capsule packing and prevent cold flow.
- **Integral ball stem** - machined from single piece bar stock. - eliminates the backlash during handle actuation.
- **One-piece body** - reduces the number of potential leak points.

Materials of Construction

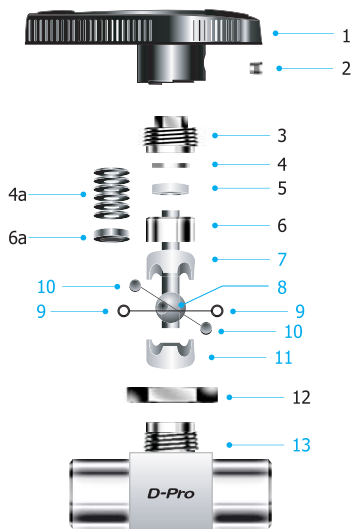

Component	Valve Body Materials	
	Stainless Steel	Brass
	Grade/ASTM Specification	
1. Handle	Nylon with brass insert	
2. Set Screw	17-4PH/A564	
3. Packing bolt ①	SS316/A276 or A479	Brass B16
4. Upper Gland	SS316/A276 or A479	
4a. Packing Spring (VL82 series)	17-4PH/A693	
5. Bushing	PTFE/D1710 type 1, Grade 1, Class B	
6. Lower gland	SS316/A276	Brass B16
6a. Packing Gland (VL82 series)	SS316/A276	
7 & 11. Upper & Lower Packing	PTFE/D1710 type 1	
8. Ball stem	SS316/A276	
9. Support rings	SS316 powered metal/B783	
10. Side discs	(fluorocarbon coating)	
12. Panel nut	SS316/A276	Brass B16
13. Body	SS316/A276 or A479	

- ① Molybdenum disulfide with hydrocarbon coating.
 ■ Note: 1. Wetted parts and lubricants are listed in blue.
 2. Lubricant is Fluorinated-based. Lubricants are available for a specific application.

Operation & Packing Adjustment

- V82 valves are designed to control fluid in full open and closed position; using V82 valves to throttle the flow may reduce the valve life.
- Valves that have not been actuated for a period of time may have a higher initial actuation torque.
- Every valve working pressure is adjusted for factory test at 1000 psig (68.9 bar) @ 21°C (70°F). For use in higher pressure, the valve packing may be required for re-adjustment.
- Packing adjustment may be required during the valve in service.

Application

- Analytical market requiring a valve with lowest dead volume to prevent fluid entrapment which can cause contamination.
- Control Sampling Systems, and Process Instrumentation market requiring a valve with compact size, high flow capacity and directional indication of flow.

Factory Test and Packaging

- Every valve is factory tested with nitrogen gas at 1000 psig (68.9 bar) for leakage at seat to a maximum allowable leak rate of 0.1 SCCM. The packing is tested with nitrogen gas for no detectable leakage.
- Every valve is cleaned and packaged in accordance with DK cleaning standard DC-01



2-way On-off Valves

In-line pattern

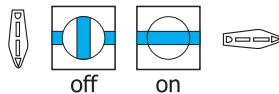
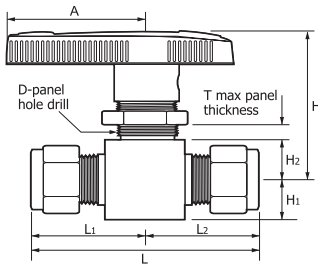

① T panel: 3.2 mm (1/8 inch) minimum panel thickness.

Angle pattern

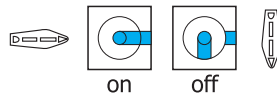
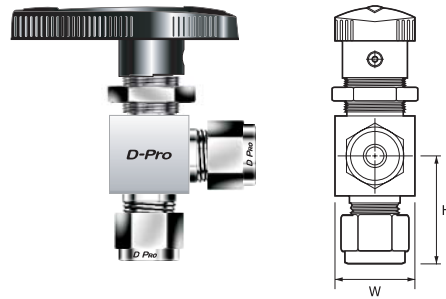

Ordering designator: -A

Top mounting option

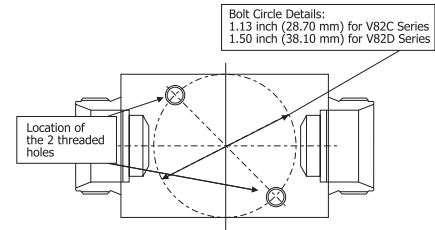

Hole details:
M5 x 0.8 pitch threads,
0.20 inch (5.0 mm) deep

Ordering designator: -TM

Technical Data for V82 series with standard PTFE seat

Valve Series		Pressure Rating		Temp. Range
In-Line pattern	Angle pattern	psig	bar	PTFE seat
V82A	V82A-A, V82B-A	2500	172	10°C to 65°C (50°F to 150°F)
V82B	-	3000	206	
V82C, V82D	-	2500	172	
-	V82C-A, V82D-A	1500	103	

Technical Data for VL82 series with PTFE seat

Valve Series	Pressure Rating		Temperature Rating
	In-line pattern	psig	
VL82A series	2500	172	-54 °C to 65 °C (-65 °F to 150 °F)
VL82B series	3000	206	

To improve thermal cycle performance VL82 series has packing springs in the place of V82 series upper gland & bushing.

Ordering Information and Table of Dimensions

Basic Ordering Number	End Connections		Orifice		Cv		Dimensions mm (inches)										
	Inlet	Outlet	mm	inch	Inline	Angle	L	L1	L2	H3	H2	H1	A	T ①	D	H	W
V82A-	D1T-	1/16" Dk-Lok	1.3	0.052	0.1	-	42.7(1.68)	21.3(0.84)	21.3(0.84)	-	8.6(0.34)	7.1(0.28)	28.4(1.12)	6.4(1/4)	15.1(19/32)	34.5(1.36)	14.7(0.58)
	D2T-	1/8" Dk-Lok	2.4	0.093	0.2	0.15	51.1(2.01)	25.7(1.01)	25.7(1.01)	24.6(0.97)	8.6(0.34)	7.1(0.28)	28.4(1.12)	6.4(1/4)	15.1(19/32)	34.5(1.36)	14.7(0.58)
	D3M-	3mm Dk-Lok	2.4	0.093	0.2	0.15	51.1(2.01)	25.7(1.01)	25.7(1.01)	24.6(0.97)	8.6(0.34)	7.1(0.28)	28.4(1.12)	6.4(1/4)	15.1(19/32)	34.5(1.36)	14.7(0.58)
	D4T-	1/4" Dk-Lok	3.2	0.125	0.6	0.35	56.1(2.21)	27.9(1.10)	27.9(1.10)	27.2(1.07)	8.6(0.34)	7.1(0.28)	28.4(1.12)	6.4(1/4)	15.1(19/32)	34.5(1.36)	14.7(0.58)
	D6M-	6mm Dk-Lok	3.2	0.125	0.6	0.35	56.1(2.21)	27.9(1.10)	27.9(1.10)	27.2(1.07)	8.6(0.34)	7.1(0.28)	28.4(1.12)	6.4(1/4)	15.1(19/32)	34.5(1.36)	14.7(0.58)
	F2N-	1/8" Female NPT	3.2	0.125	0.5	0.3	41.1(1.62)	20.6(0.81)	20.6(0.81)	20.6(0.81)	8.6(0.34)	7.1(0.28)	28.4(1.12)	6.4(1/4)	15.1(19/32)	34.5(1.36)	14.7(0.58)
V82B-	D4T-	1/4" Dk-Lok	4.8	0.187	2.4	0.9	59.9(2.36)	30.0(1.18)	30.0(1.18)	29.7(1.17)	11.2(0.44)	9.7(0.38)	38.9(1.53)	4.8(3/16)	19.8(25/32)	39.6(1.56)	19.8(0.78)
	D6T-	3/8" Dk-Lok	4.8	0.187	1.5	0.9	65.5(2.58)	32.8(1.29)	32.8(1.29)	32.8(1.29)	11.2(0.44)	9.7(0.38)	38.9(1.53)	4.8(3/16)	19.8(25/32)	39.6(1.56)	19.8(0.78)
	D6M-	6mm Dk-Lok	4.8	0.187	2.4	0.9	60.7(2.39)	30.5(1.20)	30.5(1.20)	29.7(1.17)	11.2(0.44)	9.7(0.38)	38.9(1.53)	4.8(3/16)	19.8(25/32)	39.6(1.56)	19.8(0.78)
	D8M-	8mm Dk-Lok	4.8	0.187	1.5	0.9	62.5(2.46)	31.2(1.23)	31.2(1.23)	30.5(1.20)	11.2(0.44)	9.7(0.38)	38.9(1.53)	4.8(3/16)	19.8(25/32)	39.6(1.56)	19.8(0.78)
	F2N-	1/8" Female NPT	4.8	0.187	1.2	0.7	50.8(2.00)	25.4(1.00)	25.4(1.00)	25.4(1.00)	11.2(0.44)	9.7(0.38)	38.9(1.53)	4.8(3/16)	19.8(25/32)	39.6(1.56)	19.8(0.78)
	F4N-	1/4" Female NPT	4.8	0.187	0.9	0.75	52.3(2.06)	26.2(1.03)	26.2(1.03)	26.2(1.03)	11.2(0.44)	9.7(0.38)	38.9(1.53)	4.8(3/16)	19.8(25/32)	39.6(1.56)	19.8(0.78)
	M4N-	1/4" Male NPT	4.8	0.187	1.2	0.75	50.8(2.00)	25.4(1.00)	25.4(1.00)	26.2(1.03)	11.2(0.44)	9.7(0.38)	38.9(1.53)	4.8(3/16)	19.8(25/32)	39.6(1.56)	19.8(0.78)
	F4R-	1/4" ISO Female Tapered	4.8	0.187	0.9	-	52.3(2.06)	26.2(1.03)	26.2(1.03)	-	11.2(0.44)	9.7(0.38)	38.9(1.53)	4.8(3/16)	19.8(25/32)	39.6(1.56)	19.8(0.78)
V82C-	D6T-	3/8" Dk-Lok	7.1	0.281	6.0	2.0	77.5(3.05)	38.6(1.52)	38.6(1.52)	36.3(1.43)	14.2(0.56)	14.2(0.56)	50.8(2.00)	9.5(3/8)	28.6(1-1/8)	52.6(2.07)	28.4(1.12)
	D10M	10mm Dk-Lok	7.1	0.281	6.0	2.0	78.0(3.07)	38.9(1.53)	38.9(1.53)	36.9(1.43)	14.2(0.56)	14.2(0.56)	50.8(2.00)	9.5(3/8)	28.6(1-1/8)	52.6(2.07)	28.4(1.12)
	F4N-	1/4" Female NPT	7.1	0.281	3.0	1.7	63.5(2.50)	31.8(1.25)	31.8(1.25)	31.8(1.25)	14.2(0.56)	14.2(0.56)	50.8(2.00)	9.5(3/8)	28.6(1-1/8)	52.6(2.07)	28.4(1.12)
	F6N-	3/8" Female NPT	7.1	0.281	2.6	1.5	63.5(2.50)	31.8(1.25)	31.8(1.25)	31.8(1.25)	14.2(0.56)	14.2(0.56)	50.8(2.00)	9.5(3/8)	28.6(1-1/8)	52.6(2.07)	28.4(1.12)
	F6R-	3/8" ISO Female Tapered	7.1	0.281	2.6	-	63.5(2.50)	31.8(1.25)	31.8(1.25)	-	14.2(0.56)	14.2(0.56)	50.8(2.00)	9.5(3/8)	28.6(1-1/8)	52.6(2.07)	28.4(1.12)
V82D-	D8T-	1/2" Dk-Lok	10.3	0.406	12.0	4.6	99.6(3.92)	49.8(1.96)	49.8(1.96)	44.2(1.74)	17.5(0.69)	17.5(0.69)	76.2(3.00)	9.5(3/8)	38.1(1-1/2)	61.7(2.43)	38.1(1.50)
	D12T-	3/4" Dk-Lok	10.3	0.406	6.4	3.8	99.6(3.92)	49.8(1.96)	49.8(1.96)	44.2(1.74)	17.5(0.69)	17.5(0.69)	76.2(3.00)	9.5(3/8)	38.1(1-1/2)	61.7(2.43)	38.1(1.50)
	D12M-	12mm Dk-Lok	9.5	0.375	12.0	4.6	99.6(3.92)	49.8(1.96)	49.8(1.96)	44.2(1.74)	17.5(0.69)	17.5(0.69)	76.2(3.00)	9.5(3/8)	38.1(1-1/2)	61.7(2.43)	38.1(1.50)
	F8N-	1/2" Female NPT	10.3	0.406	6.3	3.5	79.2(3.12)	39.6(1.56)	39.6(1.56)	39.6(1.56)	17.5(0.69)	17.5(0.69)	76.2(3.00)	9.5(3/8)	38.1(1-1/2)	61.7(2.43)	38.1(1.50)
	F8R-	1/2" ISO Female Tapered	10.3	0.406	6.3	-	79.2(3.12)	39.6(1.56)	39.6(1.56)	-	17.5(0.69)	17.5(0.69)	76.2(3.00)	9.5(3/8)	38.1(1-1/2)	61.7(2.43)	38.1(1.50)

All dimensions shown are for reference only and are subject to change. Dimensions with Dk-Lok nuts are in finger-tight position.

Patterns: To order angle pattern, use **-A** as a suffix to the basic ordering number. Example: V82B-D-4T-A-S

Top mounting: To order Top mounting option, use **-TM** as a suffix to the basic ordering number. Example: V82C-D-6T-TM-S

3-way Switching Valves

Technical Data for valves with standard PTFE seat

Valve Series	Pressure Rating		Temperature Range
	psig	bar	PTFE seat
V82A-3B, V82B-3B	2500	172	10 °C to 65 °C
V82C-3B, V82D-3B	1500	103	(50 °F to 150 °F)

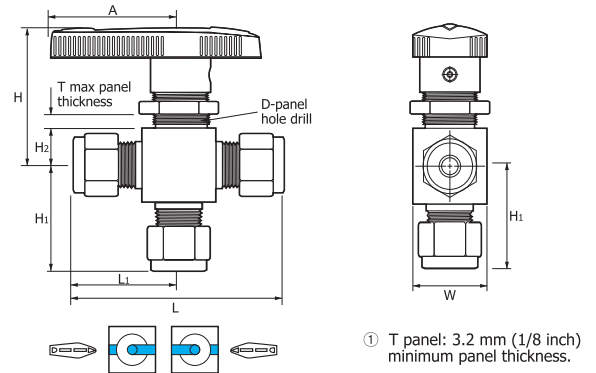

Ordering Information and Table of Dimensions

Basic Ordering Number	End Connections	Orifice		Cv	Dimensions mm (inches)									
		mm	inch		L	L1	H1	H2	A	T ^①	D	H	W	
V823A-	D1T-	1/16" Dk-Lok	1.3	0.052	0.08	42.7(1.68)	21.3(0.84)	20.6(0.81)	8.6(0.34)	28.7(1.13)	6.4(1/4)	15.0(19/32)	34.5(1.36)	14.7(0.58)
	D2T-	1/8" Dk-Lok	2.4	0.093	0.15	51.1(2.01)	25.7(1.01)	24.6(0.97)	8.6(0.34)	28.7(1.13)	6.4(1/4)	15.0(19/32)	34.5(1.36)	14.7(0.58)
	D4T-	1/4" Dk-Lok	3.2	0.125	0.35	56.1(2.21)	27.9(1.10)	27.2(1.07)	8.6(0.34)	28.7(1.13)	6.4(1/4)	15.0(19/32)	34.5(1.36)	14.7(0.58)
	D3M-	3mm Dk-Lok	2.4	0.093	0.15	51.1(2.01)	25.7(1.01)	24.6(0.97)	8.6(0.34)	28.7(1.13)	6.4(1/4)	15.0(19/32)	34.5(1.36)	14.7(0.58)
	D6M-	6mm Dk-Lok	3.2	0.125	0.35	56.1(2.21)	27.9(1.10)	27.2(1.07)	8.6(0.34)	28.7(1.13)	6.4(1/4)	15.0(19/32)	34.5(1.36)	14.7(0.58)
	F2N-	1/8" Female NPT	3.2	0.125	0.3	41.4(1.63)	20.6(0.81)	20.6(0.81)	8.6(0.34)	28.7(1.13)	6.4(1/4)	15.0(19/32)	34.5(1.36)	14.7(0.58)
V823B-	D4T-	1/4" Dk-Lok	4.8	0.187	0.90	60.7(2.39)	30.5(1.20)	29.7(1.17)	11.2(0.44)	38.9(1.53)	4.8(3/16)	19.8(25/32)	39.6(1.56)	19.8(0.78)
	D6M-	6mm Dk-Lok	4.8	0.187	0.90	60.7(2.39)	30.5(1.20)	29.7(1.17)	11.2(0.44)	38.9(1.53)	4.8(3/16)	19.8(25/32)	39.6(1.56)	19.8(0.78)
	D8M-	8mm Dk-Lok	4.8	0.187	0.80	62.5(2.46)	31.2(1.23)	30.5(1.20)	11.2(0.44)	38.9(1.53)	4.8(3/16)	19.8(25/32)	39.6(1.56)	19.8(0.78)
	F4N-	1/4" Female NPT	4.8	0.187	0.75	52.3(2.06)	26.2(1.03)	26.2(1.03)	11.2(0.44)	38.9(1.53)	4.8(3/16)	19.8(25/32)	39.6(1.56)	19.8(0.78)
	F4R-	1/4" ISO Female Tapered	4.8	0.187	0.75	52.3(2.06)	26.2(1.03)	26.2(1.03)	11.2(0.44)	38.9(1.53)	4.8(3/16)	19.8(25/32)	39.6(1.56)	19.8(0.78)
V823C-	D6T-	3/8" Dk-Lok	7.1	0.281	2.0	73.4(2.89)	36.8(1.45)	36.3(1.43)	14.2(0.56)	50.8(2.00)	9.7(3/8)	28.7(1-1/8)	52.6(2.07)	28.4(1.12)
	D10M-	10mm Dk-Lok	7.1	0.281	2.0	73.4(2.89)	36.8(1.45)	36.3(1.43)	14.2(0.56)	50.8(2.00)	9.7(3/8)	28.7(1-1/8)	52.6(2.07)	28.4(1.12)
	F4N-	1/4" Female NPT	7.1	0.281	1.7	63.5(2.50)	31.8(1.25)	31.8(1.25)	14.2(0.56)	50.8(2.00)	9.7(3/8)	28.7(1-1/8)	52.6(2.07)	28.4(1.12)
	F6N-	3/8" Female NPT	7.1	0.281	1.5	63.5(2.50)	31.8(1.25)	31.8(1.25)	14.2(0.56)	50.8(2.00)	9.7(3/8)	28.7(1-1/8)	52.6(2.07)	28.4(1.12)
	F6R-	3/8" ISO Female Tapered	7.1	0.281	1.5	63.5(2.50)	31.8(1.25)	31.8(1.25)	14.2(0.56)	50.8(2.00)	9.7(3/8)	28.7(1-1/8)	52.6(2.07)	28.4(1.12)
	D8T-	1/2" Dk-Lok	10.3	0.406	4.6	88.4(3.48)	44.2(1.74)	44.2(1.74)	17.5(0.69)	76.2(3.00)	9.7(3/8)	38.1(1-1/2)	61.7(2.43)	38.1(1.50)
V823D-	D12T-	3/4" Dk-Lok	10.3	0.406	3.8	88.4(3.48)	44.2(1.74)	44.2(1.74)	17.5(0.69)	76.2(3.00)	9.7(3/8)	38.1(1-1/2)	61.7(2.43)	38.1(1.50)
	D12M-	12mm Dk-Lok	9.5	0.375	4.6	88.4(3.48)	44.2(1.74)	44.2(1.74)	17.5(0.69)	76.2(3.00)	9.7(3/8)	38.1(1-1/2)	61.7(2.43)	38.1(1.50)
	F8N-	1/2" Female NPT	10.3	0.406	3.5	79.5(3.13)	39.6(1.56)	39.6(1.56)	17.5(0.69)	76.2(3.00)	9.7(3/8)	38.1(1-1/2)	61.7(2.43)	38.1(1.50)
	F8R-	1/2" ISO Female Tapered	10.3	0.406	3.5	79.5(3.13)	39.6(1.56)	39.6(1.56)	17.5(0.69)	76.2(3.00)	9.7(3/8)	38.1(1-1/2)	61.7(2.43)	38.1(1.50)

All dimensions shown are for reference only and are subject to change. Dimensions with Dk-Lok nuts are in finger-tight position.

Flow Data

2-way

Cv	Water US GPM (L/min.)			Air SCFM (NL/min.)		
	@21°C (70°F)			@21°C (70°F)		
	Pressure Drop to Atmosphere (Δp) psi (bar)					
	10 (0.7)	50 (3.5)	100 (7.0)	10 (0.7)	50 (3.5)	100 (7.0)
0.1	0.3(1.1)	0.7(2.6)	1.0(3.8)	1.1(31)	3.0(85)	5.3(150)
0.2	0.6(2.3)	1.4(5.3)	2.0(7.6)	2.3(76)	6.0(215)	11.0(396)
0.5	1.6(5.7)	3.5(13.2)	5.0(18.9)	5.6(195)	15.0(538)	27.0(963)
0.6	1.9(7.2)	4.2(15.9)	6.0(22.7)	6.8(235)	18.0(651)	32.0(1161)
0.9	2.8(10.6)	6.4(23.8)	9.0(34.0)	10.0(340)	27.0(963)	48.0(1720)
1.2	3.8(14.0)	8.5(31.8)	12.0(45.4)	14.0(481)	36.0(1303)	64.0(2294)
1.5	4.7(17.8)	11.0(41.6)	15.0(56.8)	17.0(595)	45.0(1614)	80.0(2832)
2.4	7.6(28.4)	17.0(64.3)	24.0(90.8)	27.0(935)	72.0(2606)	120.0(4531)
2.6	8.2(31.0)	18.0(68.1)	26.0(98.4)	29.0(1020)	78.0(2804)	140.0(5098)
3.0	9.5(35.6)	21.2(79.5)	30.0(113.6)	34.0(1189)	90.0(3115)	160.0(5664)
6.0	19.0(71.9)	42.0(159.0)	60.0(227.1)	68.0(2351)	180.0(6514)	320.0(11611)
6.3	19.9(75.5)	44.5(170.3)	63.0(237.0)	71.0(2464)	190.0(6797)	340.0(12178)
6.4	20.2(75.7)	45.3(170.3)	64.0(242.2)	72.0(2520)	190.0(6797)	340.0(12178)
12.0	37.9(143.8)	84.9(321.7)	120.0(454.2)	130.0(4814)	360.0(13027)	640.0(22939)

2-way angle pattern and 3-way

Cv	Water US GPM (L/min.)			Air SCFM (NL/min.)		
	@21°C (70°F)			@21°C (70°F)		
	Pressure Drop to Atmosphere (Δp) psi (bar)					
	10 (0.7)	50 (3.5)	100 (7.0)	10 (0.7)	50 (3.5)	100 (7.0)
0.08	0.3(1.1)	0.6(2.3)	0.8(3.0)	0.9(26)	2.4(68)	4.3(122)
0.15	0.4(1.5)	1.0(3.8)	1.5(5.7)	1.7(57)	4.5(161)	8.0(286)
0.30	0.9(3.4)	2.1(7.9)	3.0(11.4)	3.4(116)	9.0(312)	16.0(566)
0.35	1.1(4.2)	2.4(9.1)	3.5(13.2)	4.0(136)	10.0(368)	19.0(680)
0.75	2.3(8.7)	5.3(20.1)	7.5(28.4)	8.5(283)	22.0(821)	40.0(1444)
0.80	2.5(9.5)	5.6(21.2)	8.0(30.3)	9.0(312)	24.0(878)	42.0(1529)
0.90	2.8(10.6)	6.3(23.8)	9.0(34.1)	10.0(340)	27.0(963)	48.0(1728)
1.5	4.7(17.8)	11.0(41.6)	15.0(56.8)	17.0(595)	45.0(1614)	80.0(2832)
1.7	5.3(20.1)	12.0(45.4)	17.0(64.3)	19.0(680)	51.0(1841)	90.0(3115)
2.0	6.3(23.8)	14.0(53.0)	20.0(75.7)	22.0(793)	60.0(2181)	100.0(3965)
3.5	11.0(41.6)	25.0(94.6)	35.0(132.5)	39.0(1359)	100.0(3682)	180.0(6797)
3.8	12.0(45.4)	27.0(102.2)	38.0(143.8)	43.0(1501)	110.0(3965)	200.0(7363)
4.6	15.0(56.8)	33.0(124.9)	46.0(174.1)	52.0(1812)	140.0(5098)	240.0(8779)

V825 Switching 5-way Ball Valves

Features

- Flow switches from a single port to multiple ports or from multiple ports to a single port.
- Spring-loaded detent ensures exact port positioning.

Technical Data with standard PTFE seat

Valve Series	Pressure Rating @ 37 °C (100 °F)		Temperature Range
	bar	psig	
V825A	172	2500	10 to 65 °C
V825B	103	1500	50 to 150 °F

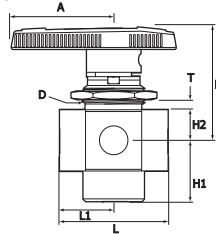

Ordering Information and Table of Dimensions

Ordering Number	End Connection	Cv	Orifice		Dimensions, mm(in.)								
			mm	inch	L	L1	H1	H2	A	T*	D	H	
V825A-	F2N-S	1/8 in. Female NPT	0.07	1.6	0.062	39.4	19.8	22.4	11.2	38.9	4.1	23.1	42.9
	F2G-S	1/8 in. ISO Parallel Threads				(1.94)	(0.78)	(0.88)	(0.44)	(1.53)	(5/32)	(29/32)	(1.69)
V825B-	F8N-S	1/2 in. Female NPT	3.5	10.3	0.406	79.5 (3.13)	39.6 (1.56)	39.6 (1.56)	17.5 (0.69)	76.2 (3.00)	9.7 (3/8)	38.1 (1 1/2)	61.7 (2.43)

T* indicates the maximum panel thickness. 3.2 mm (1/8 in.) minimum panel thickness.
 D : Panel hole

V824 Crossover 4-way Ball Valves

Features

- Crossover of two streams
- Mechanical stop ensures positive port positioning

Technical Data with standard PTFE seat

Valve Series	Pressure Rating @ 37 °C (100 °F)		Temperature Range
	bar	psig	
V824A	172	2500	10 to 65 °C
V824B	103	1500	50 to 150 °F

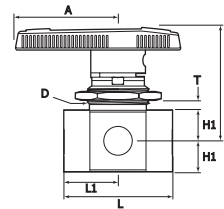
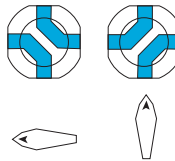

Ordering Information and Table of Dimensions

Ordering Number	End Connection	Cv	Orifice		Dimensions, mm(in.)							
			mm	inch	L	L1	H1	A	T*	D	H	
V824A-	F2N-S	1/8 in. Female NPT	0.08	1.6	0.062	39.4 (1.55)	19.8 (0.78)	11.2 (0.44)	38.9 (1.53)	4.8 (3/16)	23.1 (29/32)	42.7 (1.68)
V824B-	F8N-S	1/2 in. Female NPT	1.6	7.1	0.281	79.5 (3.13)	39.6 (1.56)	17.5 (0.69)	76.2 (3.00)	9.7 (3/8)	38.1 (1 1/2)	61.7 (2.43)

T* indicates maximum panel thickness
 D : Panel Hole

Handle Options

Aluminum Bar

Add-AH to the valve ordering number.

Example: V824A-F-2N-AH-S



Stainless Bar

Add-BH to the valve ordering number.

Example: V824A-F-2N-BH-S

How to Order

Select applicable valve pattern, options and body material from designators listed below.

V824A-F2N

V825B-D4T **-A**

-NL

-AH

-B





-S

2-way	Top mounting	Valve with no lubricant	Bar handle	Body material
• A: 2-way angle pattern	• TM: top mounting Note: Top mounting option is applicable only to the in-line pattern 2-way valves.	• NL: No lubricant Valve Note: Valve with no lubricant is factory tested at 200 psig (13 bar). This valve has a pressure rating of 200 psig (13 bar).	• Nil: Standard Nylon handle • AH: Aluminum bar handle • BH: Stainless bar handle	• S: SS316 • B: Brass

Safe Valve Selection

The selection of a valve for any application or system design must be considered to ensure safe performance.

Valve function, valve rating, material compatibility, proper installation, operation and maintenance remain the sole responsibility of the system designer and the user. Dk Tech accepts no liability for any improper selection, installation, operation or maintenance.

 <p>THE POWER OF RELIABILITY DK TECH CORPORATION www.dklok.com</p>	<p>DK TECH Trademarks</p>   		<p>DK TECH contact information</p> <p>Tel. (82) 55-338-0114 Fax (82) 55-338-6745 E-mail: sales@dklok.com</p>	<p>For International customers</p> <p>Tel. (82) 55-338-0031/2 Fax (82) 55-338-6746 E-mail: dklok@dklok.com</p>
	<p>Mailing Address</p> <p>826, Naesam-Ri, Juchon-Myeon, Gimhae-City, Gyeong Nam, Korea 621-841</p>			